

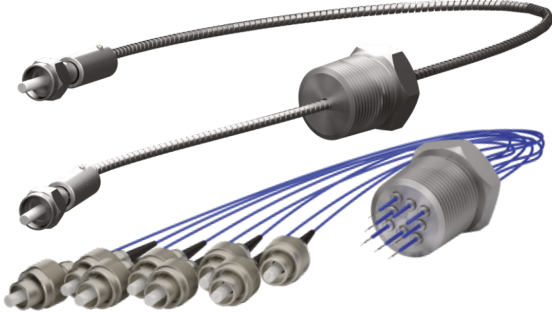

Pressure Fiber Optic Feedthrough

Glass Sealed Fiber Optic Feedthrough with Pigtail Interface



Pressure difference*	Up to 100Mpa (1000bar)
Operating temperature**	-40°C / 200°C
Sealing material	Glass solder
Hermeticity	10 ⁻⁶ to 10 ⁻¹² mbar.l/s
Fiber type	SM fiber (VIS, NIR) MM fiber (UV, VIS, NIR)
Mechanical protection	Stainless steel flexible tubing, 900um PTFE or customized
Flange type	NPT, SAE, DN, etc... customized
Flange material	Stainless steel, other
Channels/fibers	Up to several single fibers within flange. Sealing of fiber groups on request.
Connectors (stainless steel)	FC/PC, FC/APC, ST/PC, SMA 905, MIL-DTL-38999, other

*Depens on overall configuration ** Depends on fiber type

SQS has a long term experience in the designing and manufacturing of FO feedthroughs with hermetically sealed optical fibers within metal flange for use in various branches of industry, in military applications, oil and gas appl. etc. SQS offers custom made solution with respect to the mechanical and optical performance for own feedthrough. SQS offers a variety of solutions in terms of operating temperatures, pressure differences, thicknesses and resistance to various liquids, gasses etc.

SQS offers a wide range of different types of feedthroughs. SQS is able to seal the several single fibers or group of fibers within a required flange which allows to offer special feedthroughs with high quantity of transmission channels.

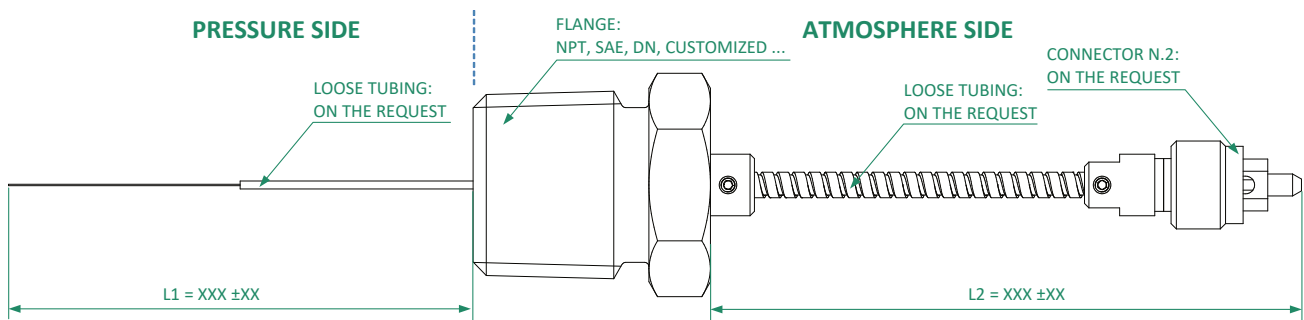

Several variants of Pressure Feedthroughs (many other configuration are possible):

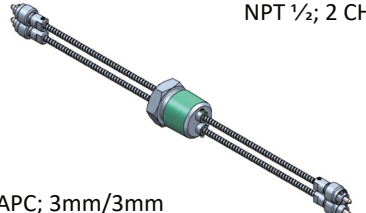
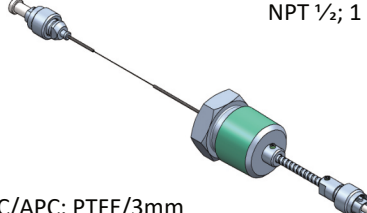
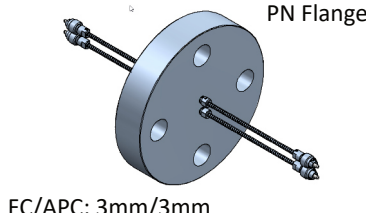
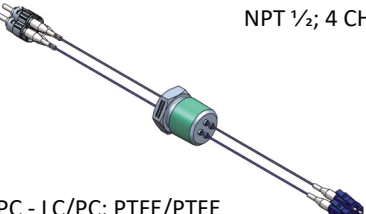
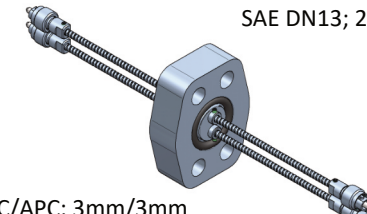
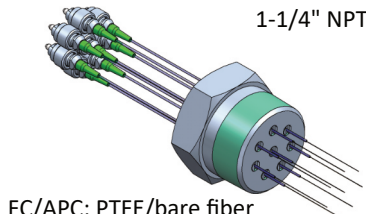
 <p>NPT 1/2; 2 CH</p> <p>FC/APC; 3mm/3mm</p>	 <p>NPT 1/2; 1 CH</p> <p>FC/APC; PTFE/3mm</p>	 <p>PN Flange; 2CH</p> <p>FC/APC; 3mm/3mm</p>
 <p>NPT 1/2; 4 CH</p> <p>ST/PC - LC/PC; PTFE/PTFE</p>	 <p>SAE DN13; 2CH</p> <p>FC/APC; 3mm/3mm</p>	 <p>1-1/4" NPT; 8CH</p> <p>FC/APC; PTFE/bare fiber</p>

Among other things we offer: Adapter and Pigtailed Feedthrough for vacuum, Vacuum compatible cables, etc..

NPT flange, ST Connectors, Steel Jacket



NPT flange - Customer solution



NPT flange FC/PC - Customer Solution

